

**THULE**<sup>®</sup>  
SWEDEN

# ➤ Instructions

**Thule RideAlong Mini**  
100103, 100104, 100105

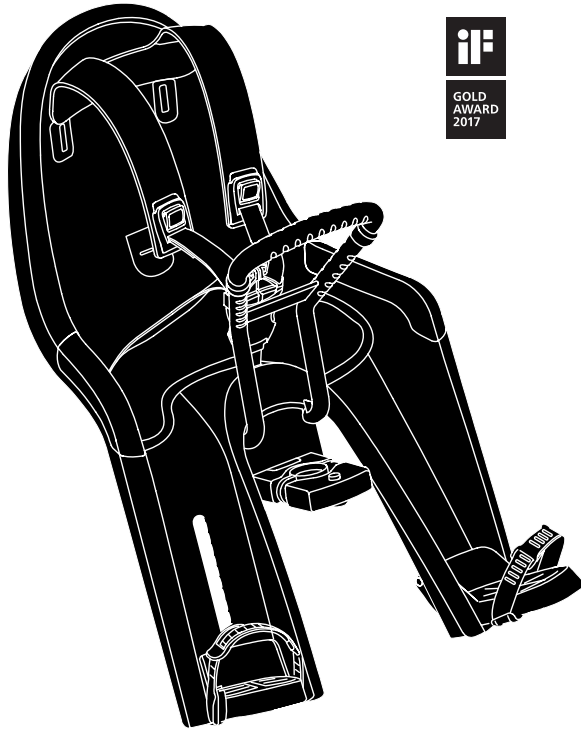

**EN** Child bike seat  
**DE** Fahrradkindersitz  
**FR** Siège vélo enfant  
**NL** Fietszitje  
**IT** Seggiolino da bici  
**ES** Portabebés bici  
**PT** Cadeira de criança para bicicleta  
**SV** Cykelbarnstol  
**DK** Cykelstol  
**NO** Barnesete til sykkel  
**FI** Polkupyörän lastenistuin  
**ET** Jalgratta lasteiste  
**LV** Velosipēda bērnu sēdekļis  
**LT** Dviračio kėdutė vaikams  
**PL** Fotelik rowerowy  
**RU** Детское велосипедное сиденье  
**UK** Дитяче велосипедне крісло  
**BG** Детско столче за велосипед  
**CS** Dětská cyklosedačka  
**SK** Detská cyklosedačka  
**SL** Otroški kolesarski sedež  
**HR/BIH** Dječja sjedalica za bicikl

**RO** Scaun de copii pentru bicicletă  
**HU** Kerékpáros gyerekülés  
**EL** Παιδικό κάθισμα ποδηλάτου  
**TR** Çocuk bisiklet koltuğu

**HE** כיסא אופניים לילד  
**AR** مقعد دراجة الطفل

**ZH** 儿童自行车座椅  
**JA** お子様用サイクルシート  
**KO** 어린이 자전거 시트  
**TH** เก้าอี้เด็กสำหรับจักรยาน

**ASTM F1625-00**

**EN 14344:2004**

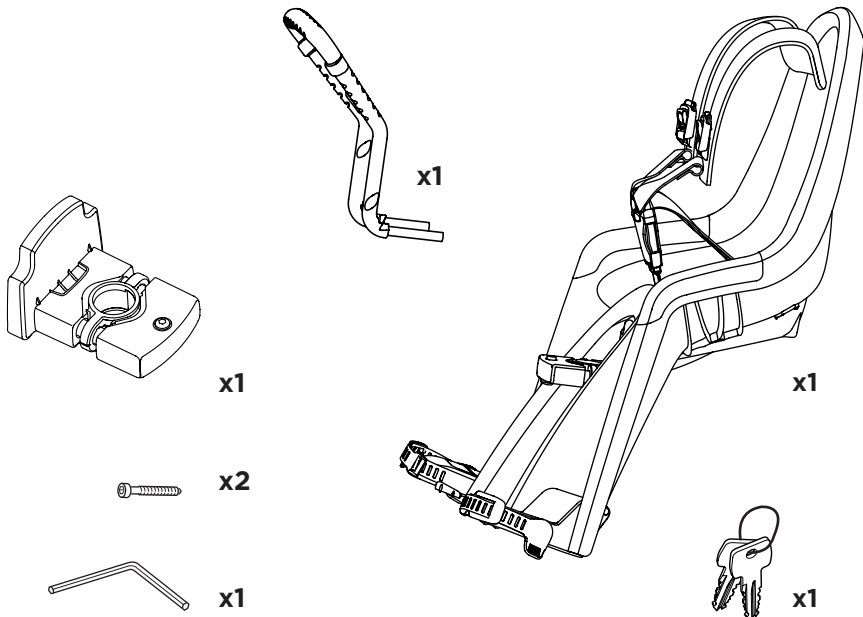
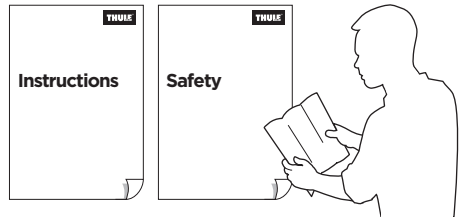



**FIT**



**9-36 M**  
**9-15 kg**  
**20-33 lbs**



Your Key-Number



**NO FIT**



**0-9 M**



Check your bike : A.2

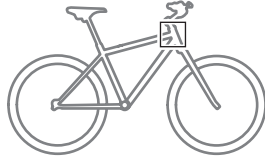

**FIT**

Min:  
24 mm  
0.94"

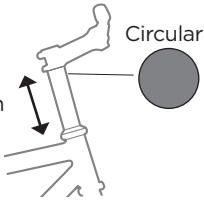

**Ok**



**No ok**



**No ok**



Max. 25 km/h  
15 mph

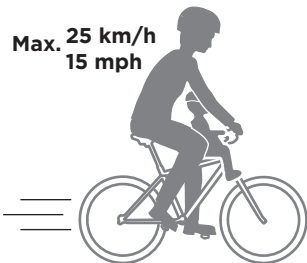

**No ok**



1

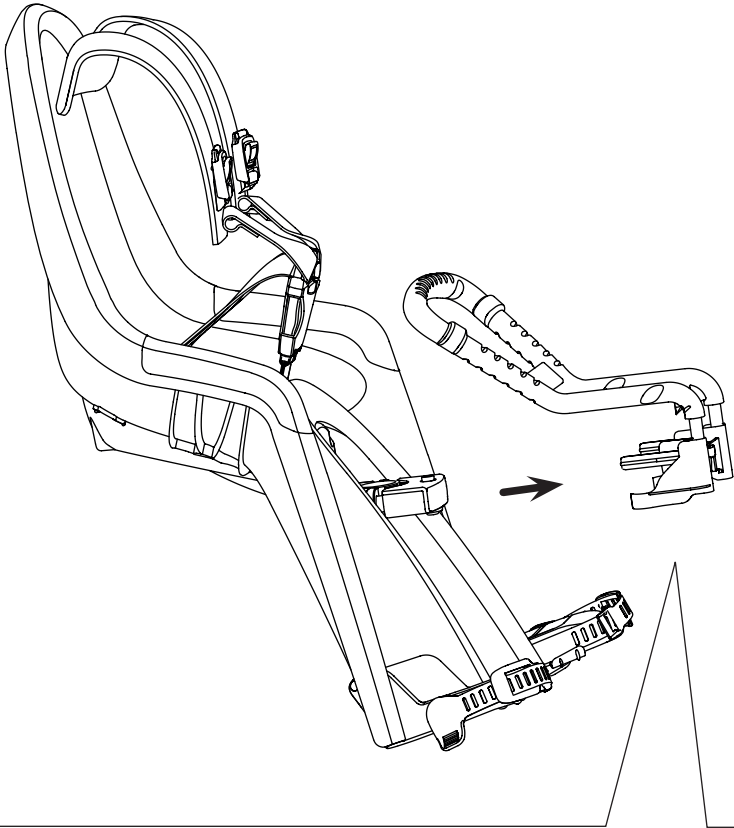

**A**

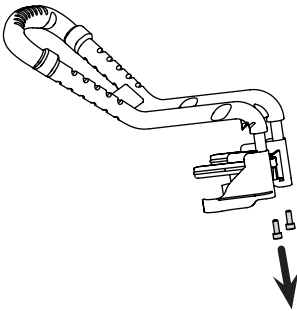

**B**

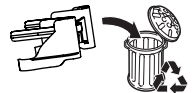
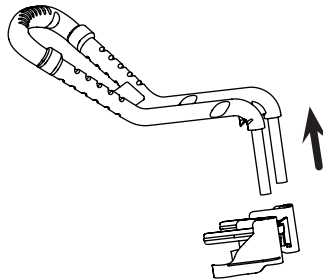

2

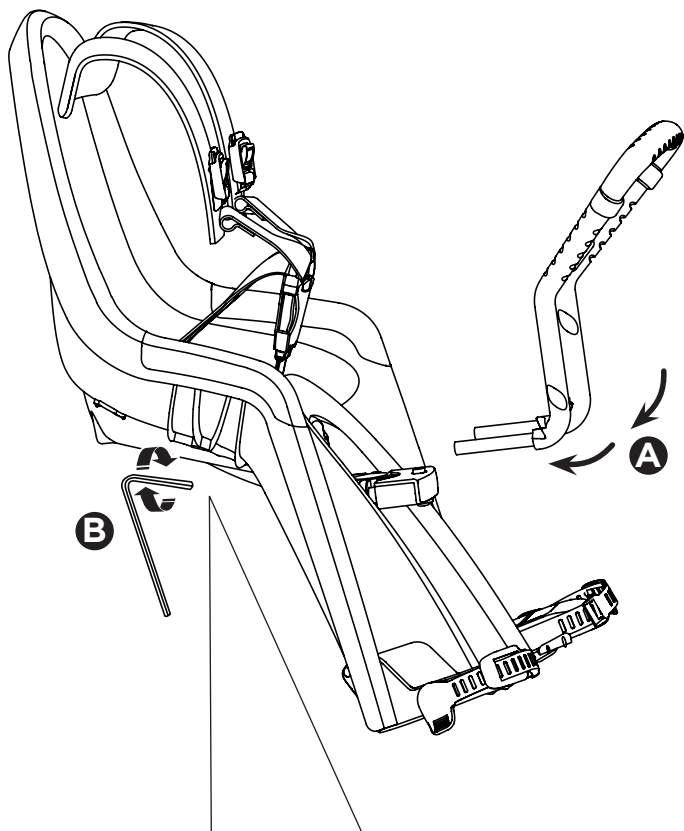

**B**

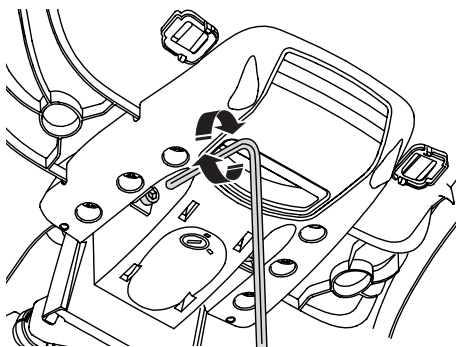

6 Nm

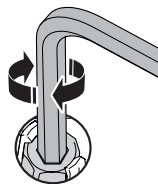

# 3 i

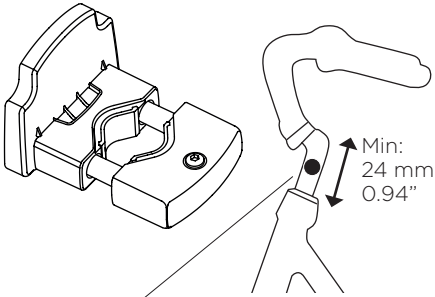

Ø 20-28 mm  
Ø 0.78-1.10"

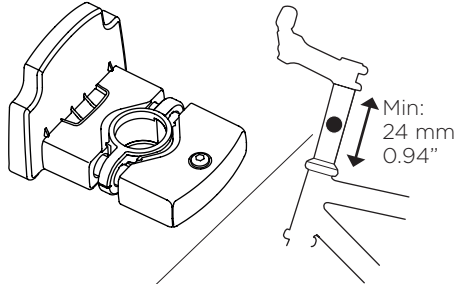

Ø 28.6 mm  
Ø 1 1/8"

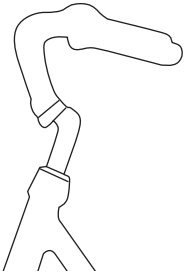

**A**

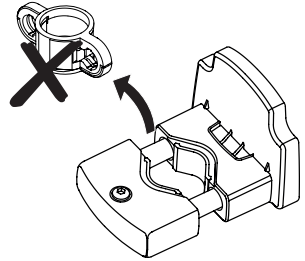

**B**

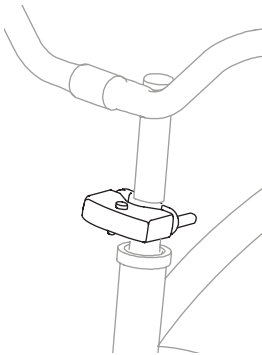

**C**

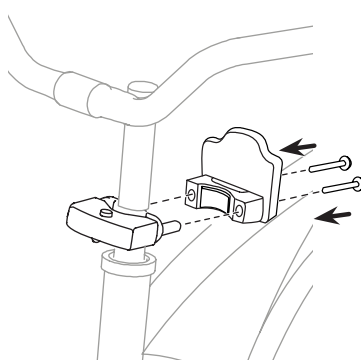

**D**

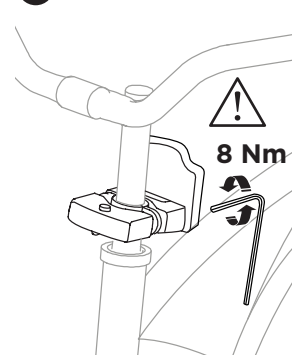

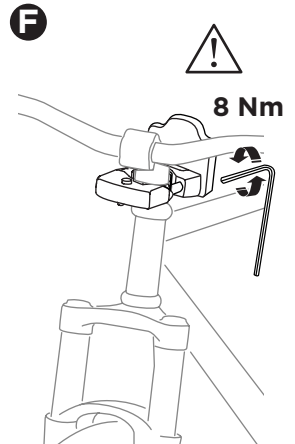
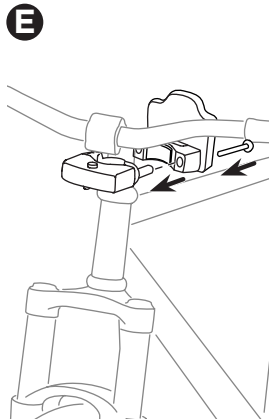
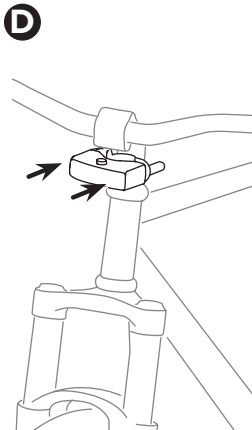
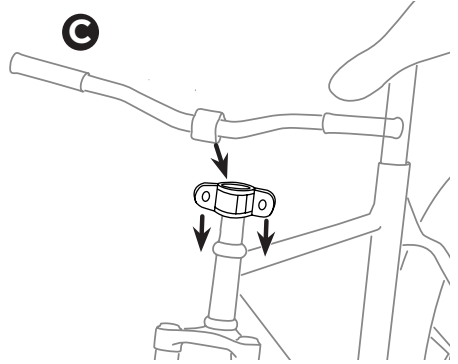
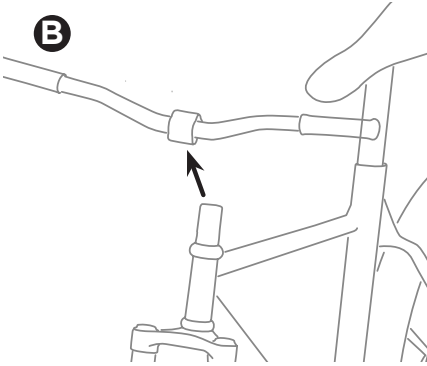
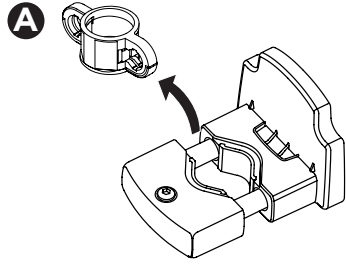
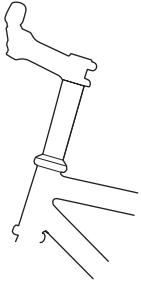

4

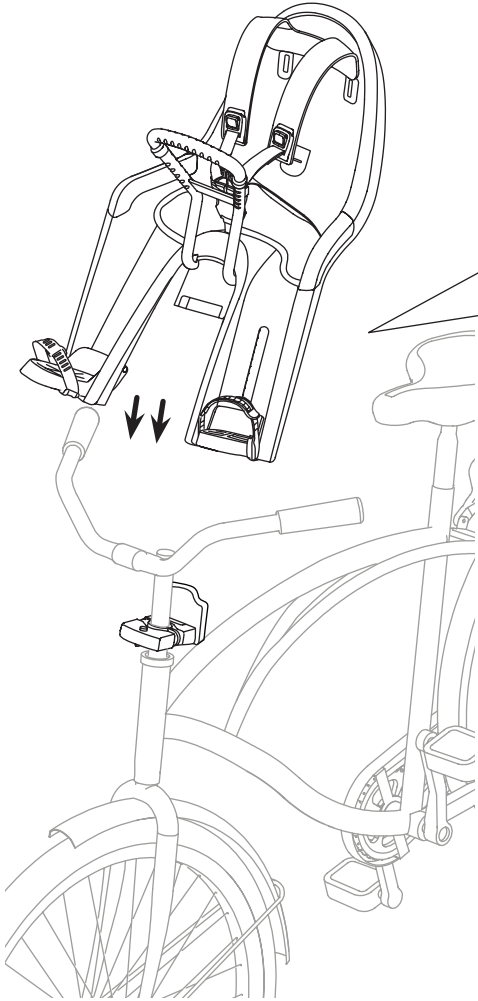

**A**

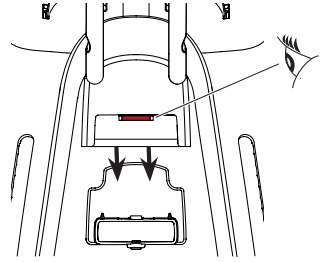

**B**

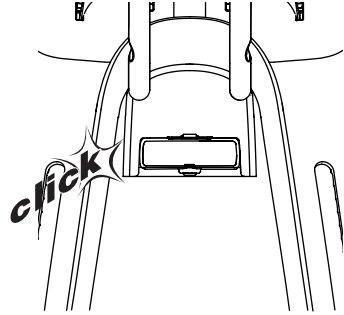

**i**

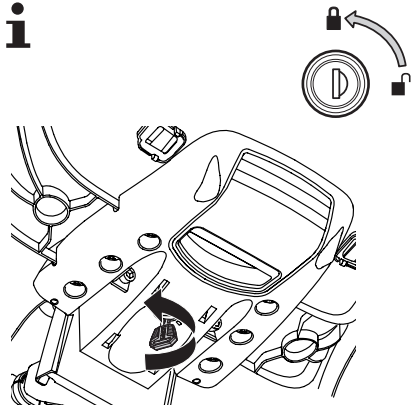



5

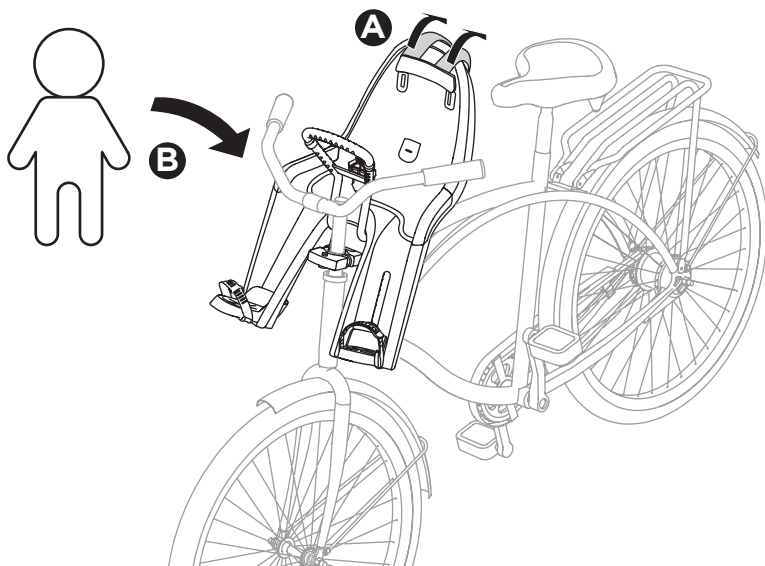
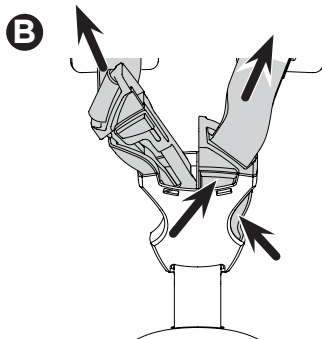
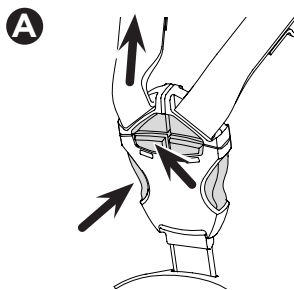
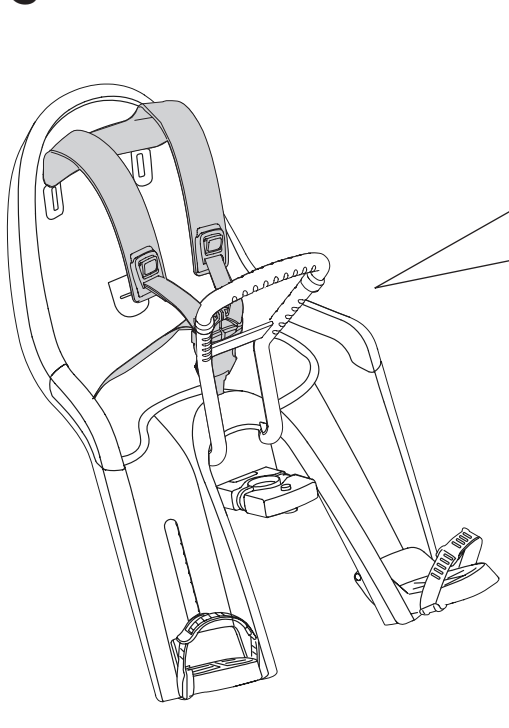

6

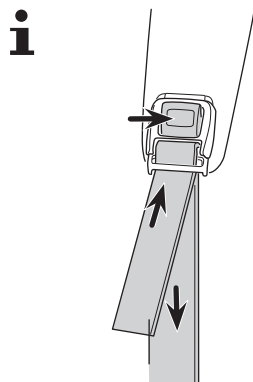
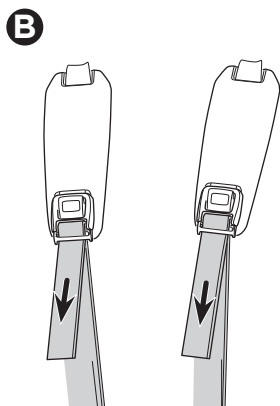
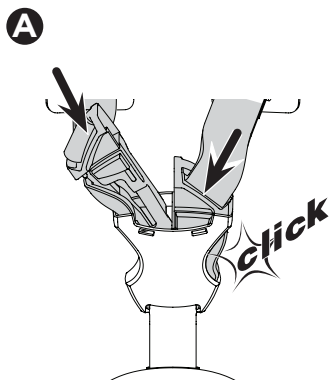
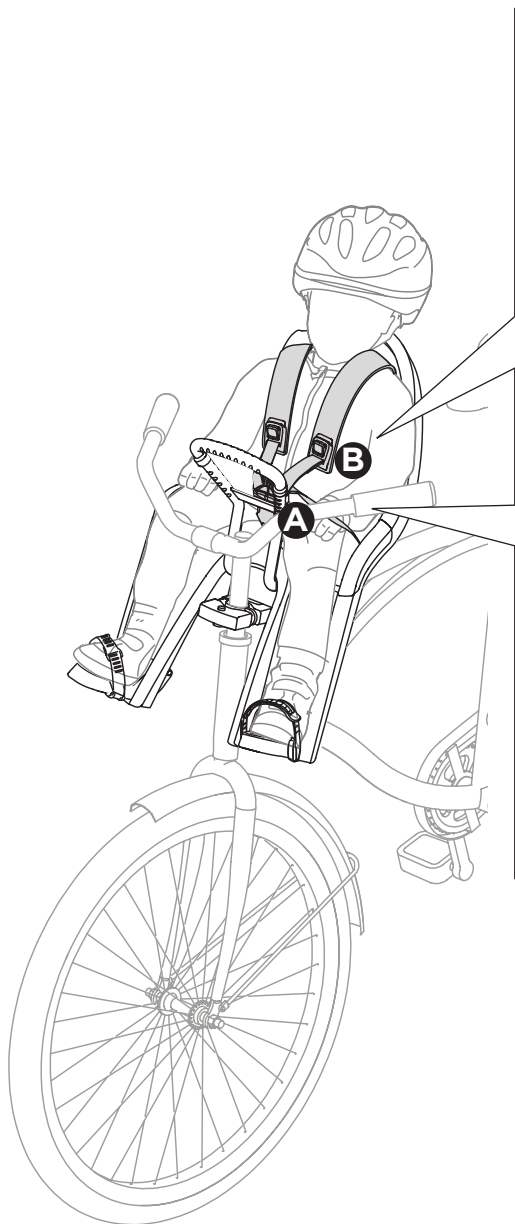

7

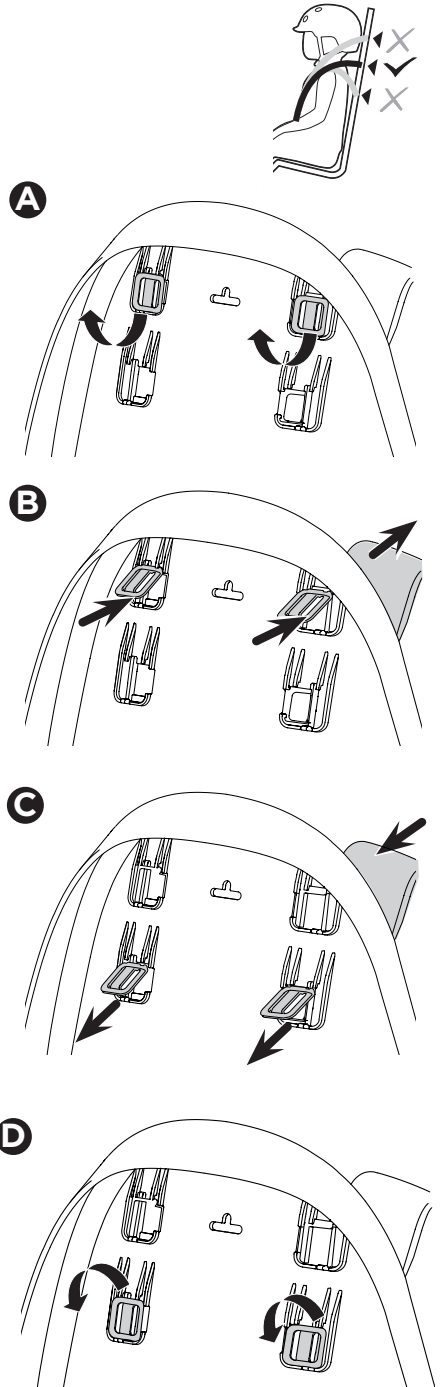
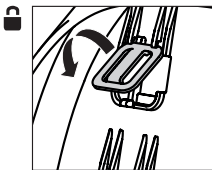
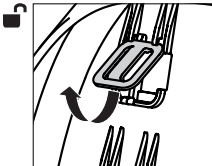
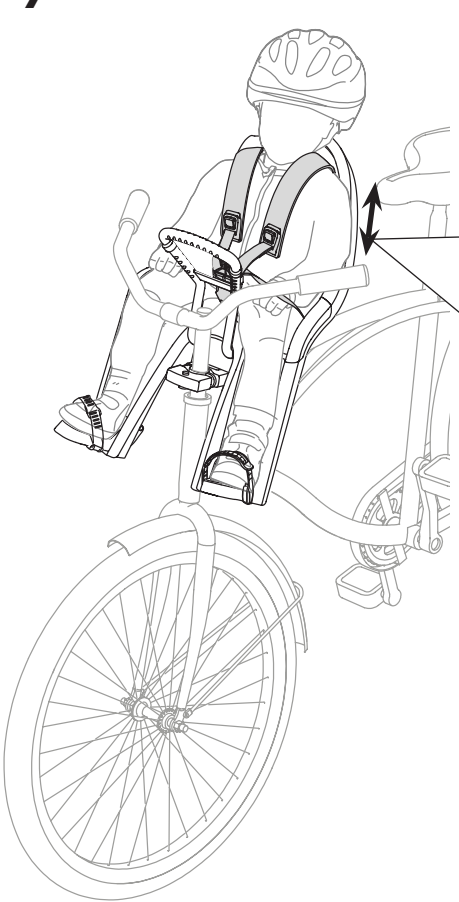

8

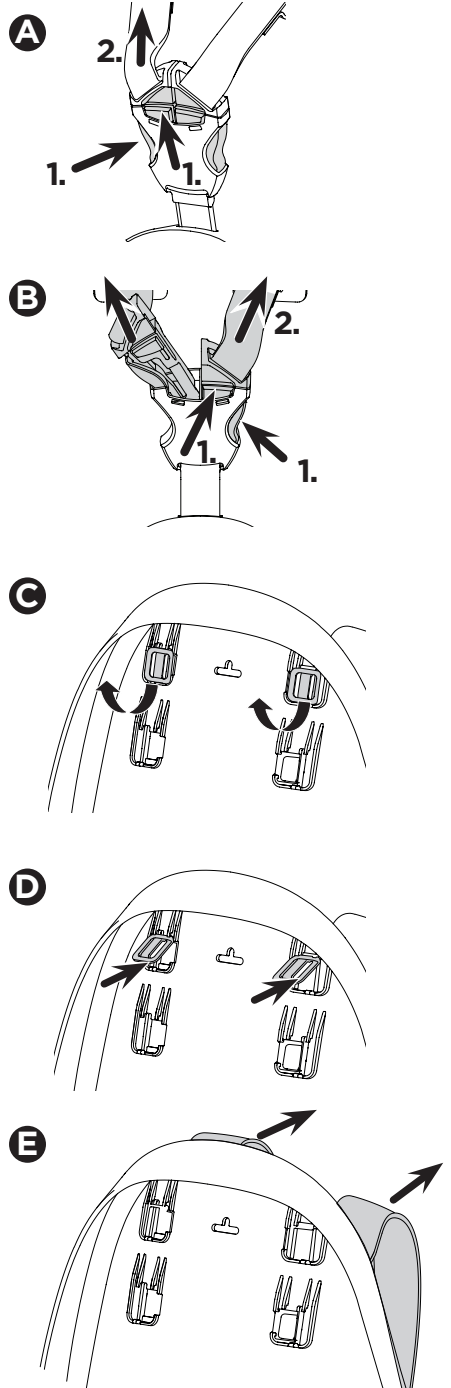
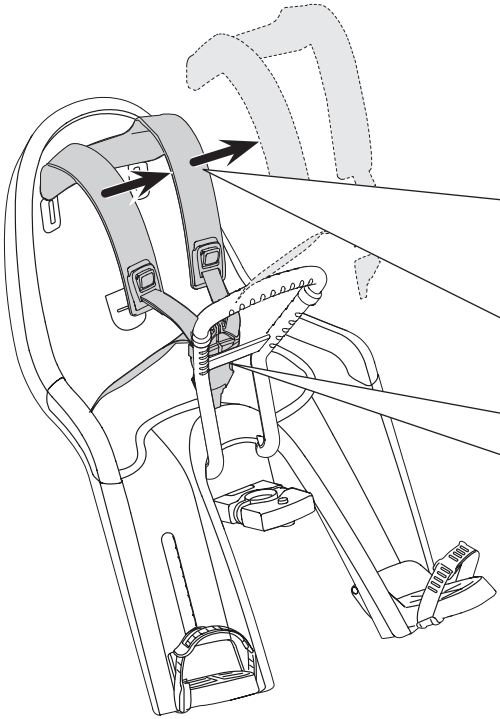

9

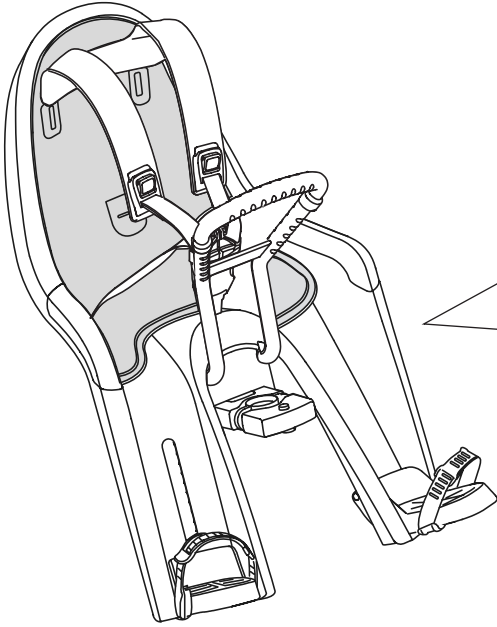

A

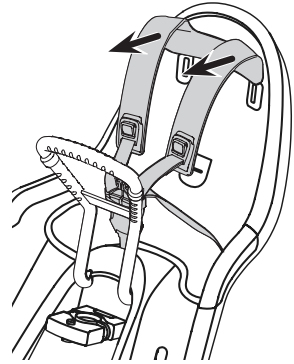

B

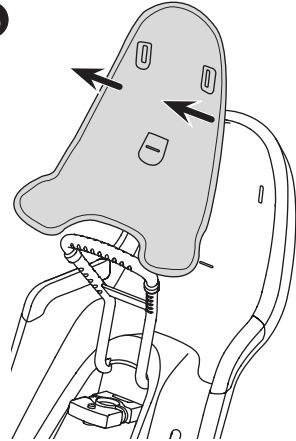

C

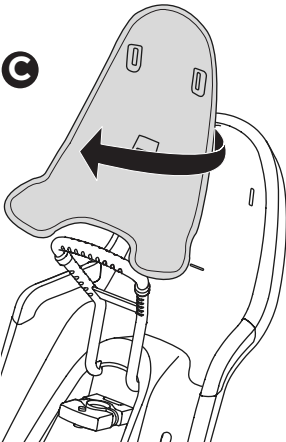

D

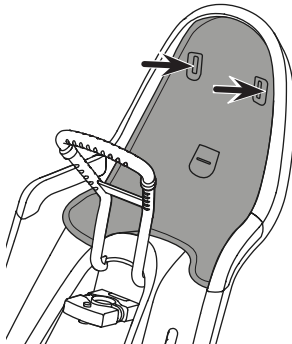

E

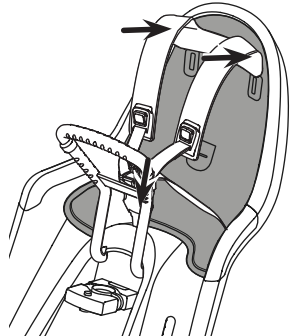

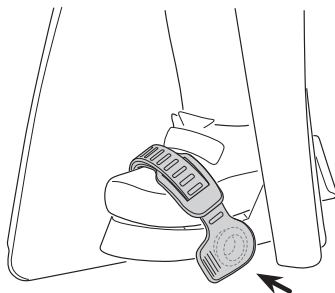
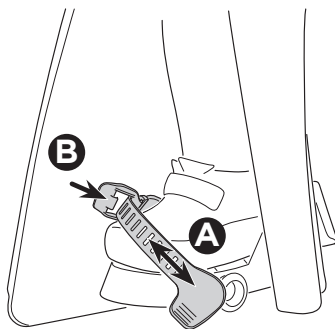
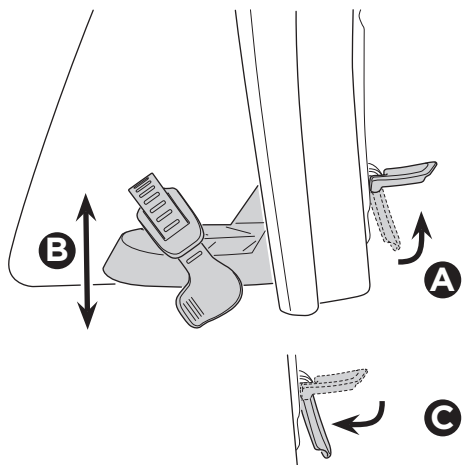
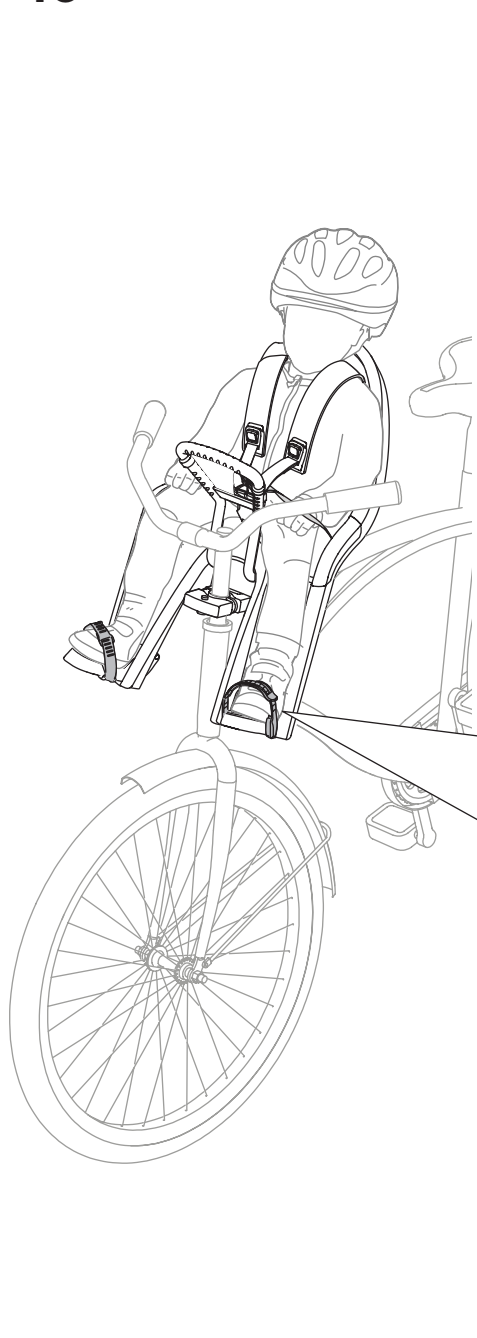

**i**

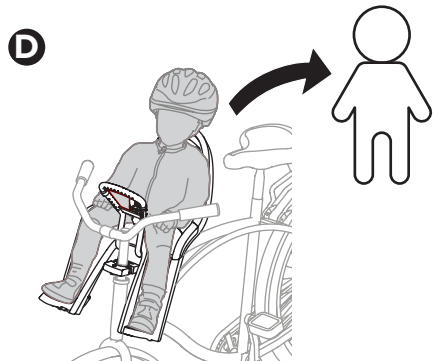
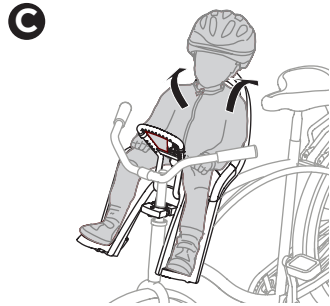
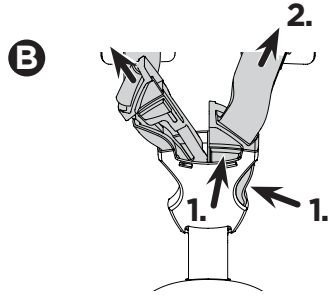
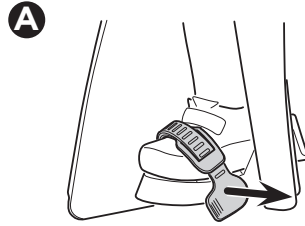

**i**

**A**

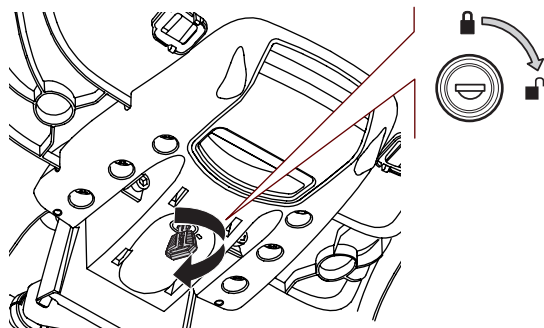

**B**

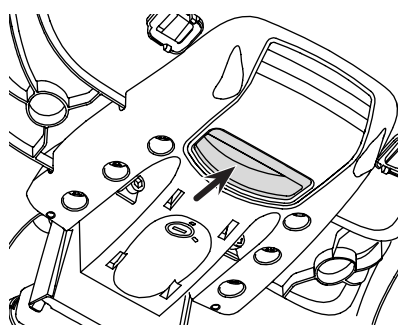

**C**

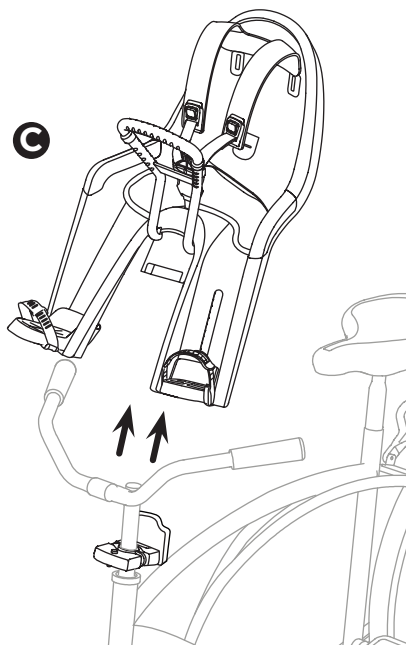

## Thule One-Key System

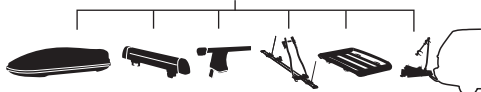

**450400**  (x4)

**450600**  (x6)

**450800**  (x8)

**451200**  (x12)

**451600**  (x16)