

# ➤ Instructions

## Thule RideAlong Lite 100109, 100110, 100111

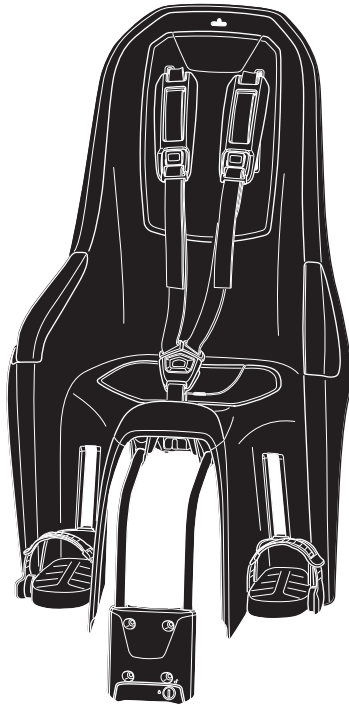

**EN** Child bike seat  
**DE** Fahrradkindsitz  
**FR** Siège vélo enfant  
**NL** Fietszitje  
**IT** Seggiolino da bici  
**ES** Portabebés bici  
**PT** Cadeira de criança para bicicleta  
**SV** Cykelbarnstol  
**DK** Cykelstol  
**NO** Barnesete til sykkel  
**FI** Polkupyörän lastenistu  
**ET** Jalgratta lasteiste  
**LV** Velosipēda bērnu sēdekļis  
**LT** Dviračio kėdutė vaikams  
**PL** Fotelik rowerowy  
**RU** Детское велосипедное сиденье  
**UK** Дитяче велосипедне крісло  
**BG** Детско столче за велосипед  
**CS** Dětská cyklosedačka  
**SK** Detská cyklosedačka  
**SL** Otroški kolesarski sedež  
**HR/BIH** Dječja sjedalica za bicikl

**RO** Scaun de copii pentru bicicletă  
**HU** Kerékpáros gyerekülés  
**EL** Παιδικό κάθισμα ποδηλάτου  
**TR** Çocuk bisiklet koltuğu

**HE** כיסא אופניים לילד  
**AR** مقعد دراجة الطفل

**ZH** 儿童自行车座椅  
**JA** お子様用サイクルシート  
**KO** 어린이 자전거 시트  
**TH** เก้าอี้เด็กสำหรับจักรยาน



**ASTM F1625-00**

**EN 14344:2004**

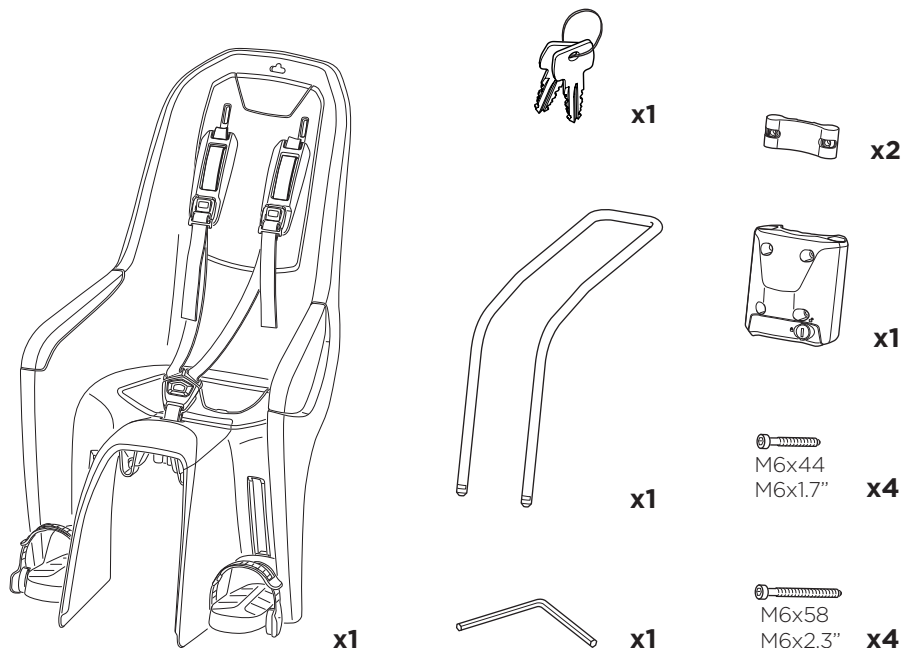
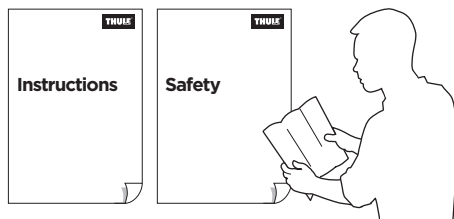



**FIT**

**Europe & rest of the world**

**USA & Canada**

9-72 M  
9-22 kg  
20-48,5 lbs

9-72 M  
9-18 kg  
20-40 lbs



Your Key-Number

Four empty boxes for entering a key number.



**NO FIT**



**0-9 M**



Check your bike : A.2

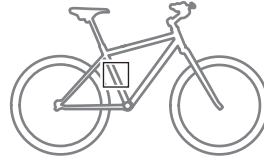

**FIT**

Circular



Ø 28-40 mm  
Ø 1,10-1,57"

Oval



Max 40 mm  
Max 1,57"



**NO FIT**

Triangular



Square

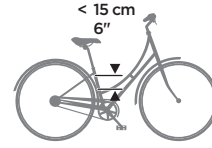
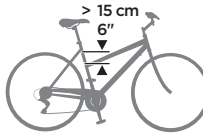

**Ok**



**No ok**



Max. 25 km/h  
15 mph

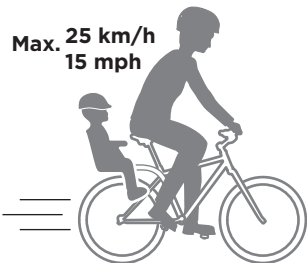

**No ok**



1

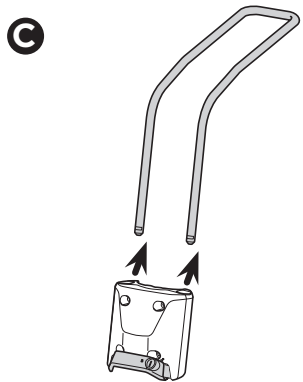
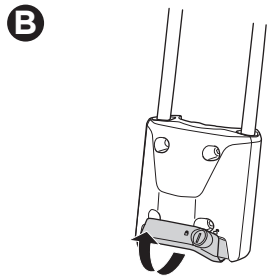
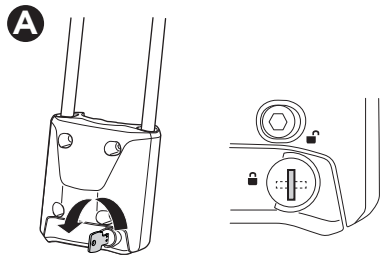
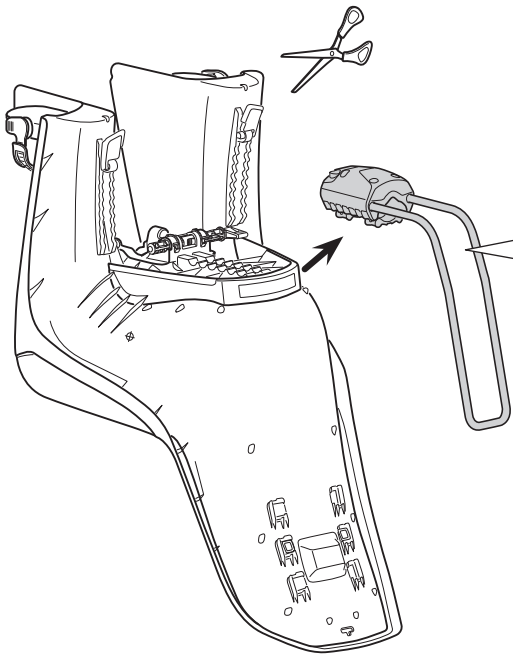

2

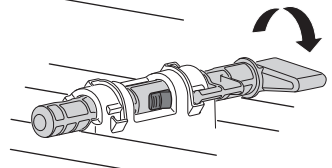
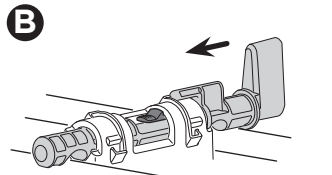
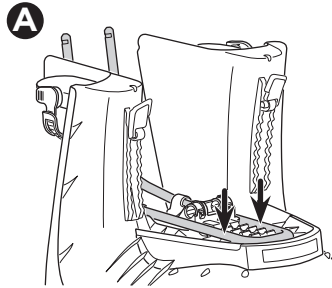
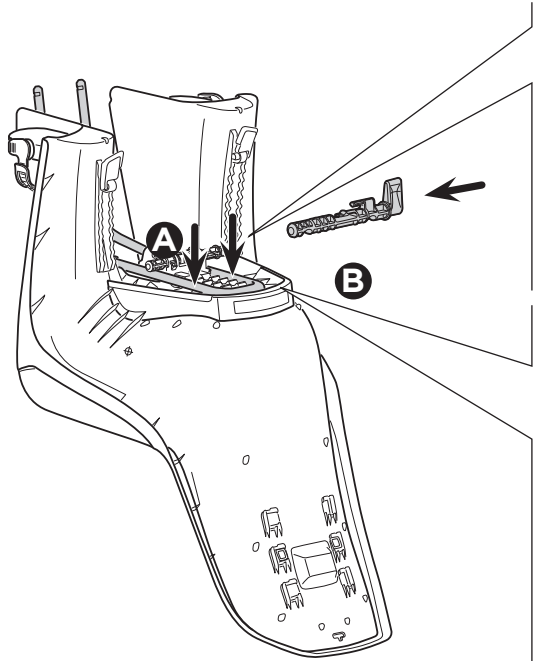
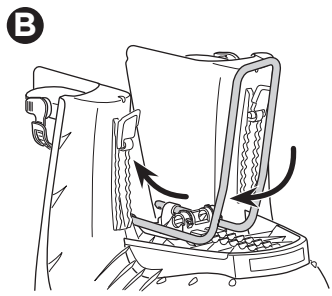
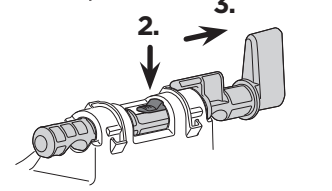
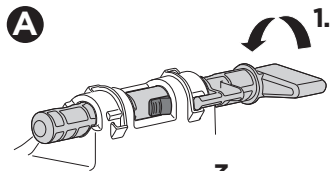
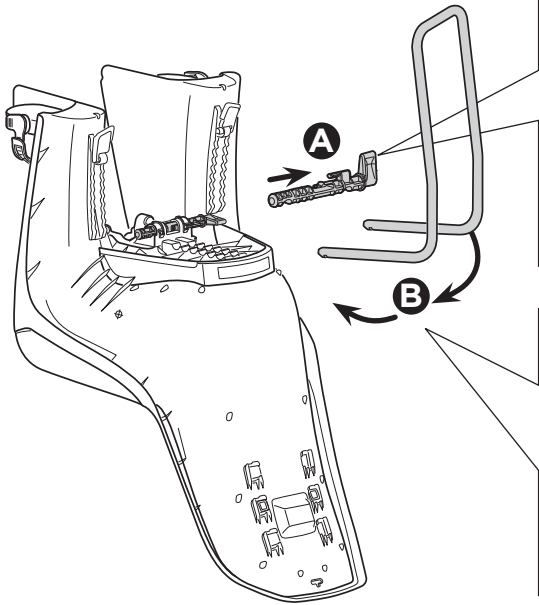

3

**i**

Ø 27.2-40 mm  
Ø 1.07-1.57"

40x55 mm  
1.57-2.16"

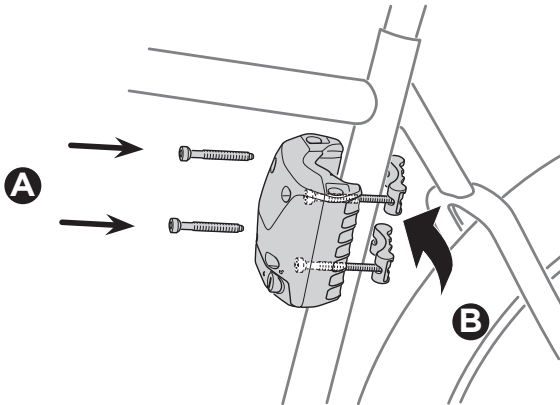
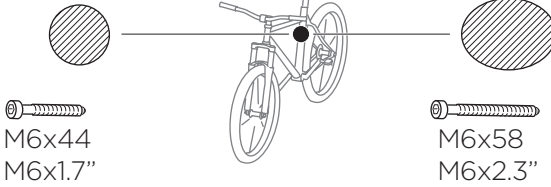

**C**

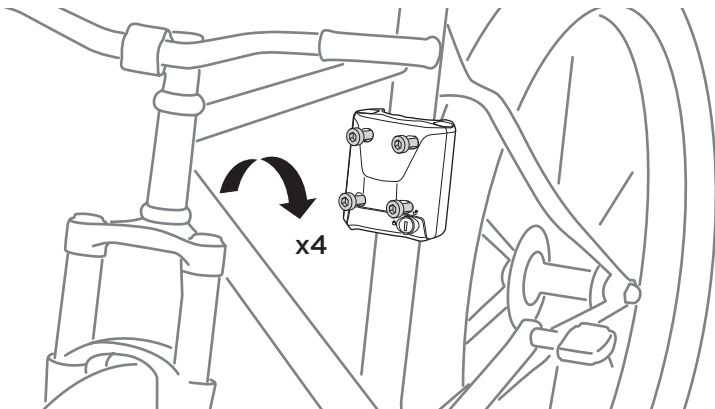

4

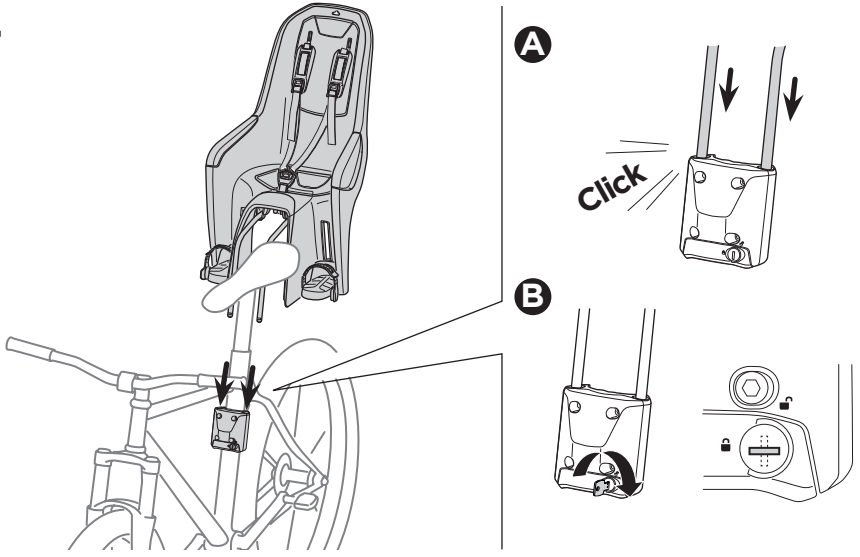

5

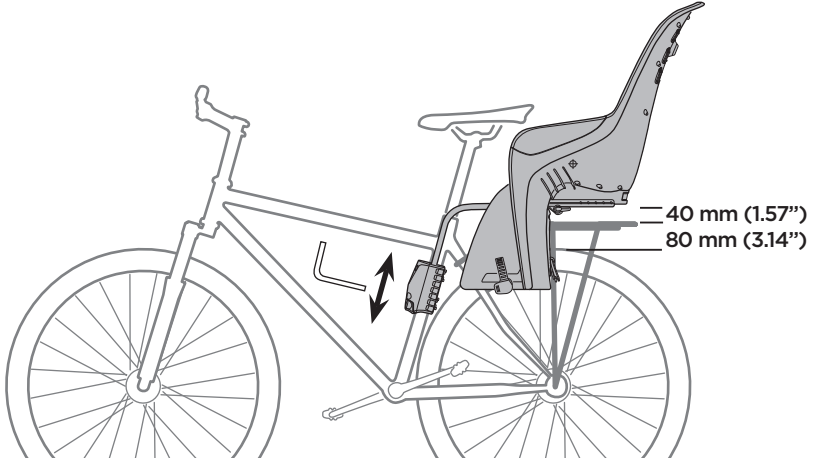

8 Nm

x4

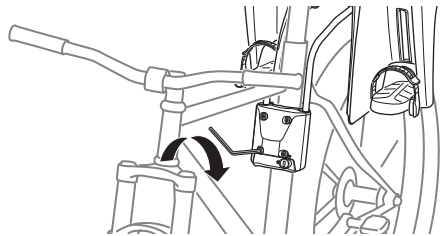

6

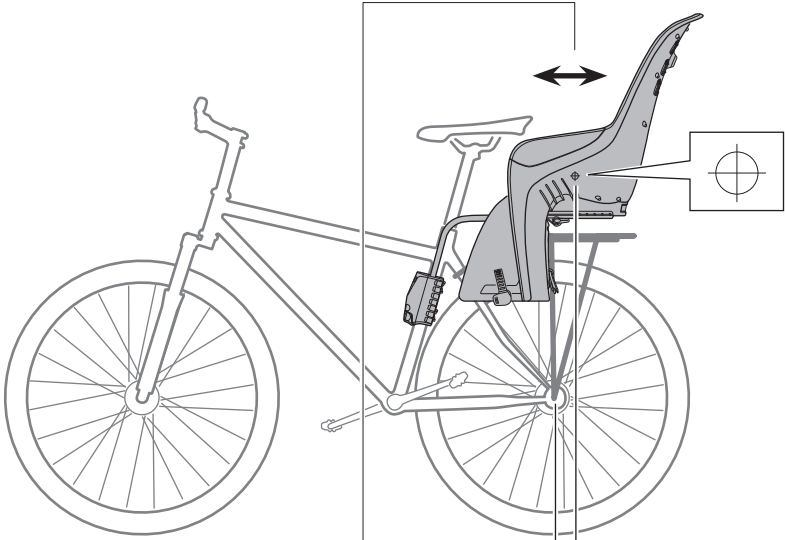
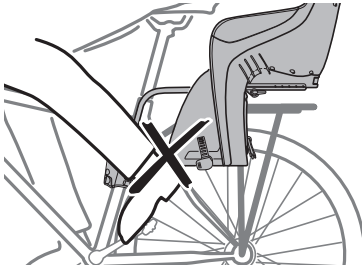

\* max 100 mm  
max (3.94")

\* DE max 0 mm

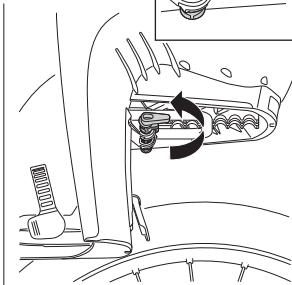
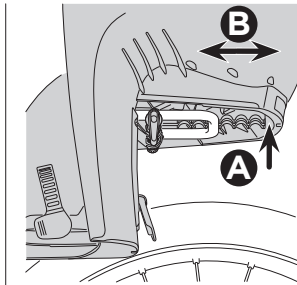
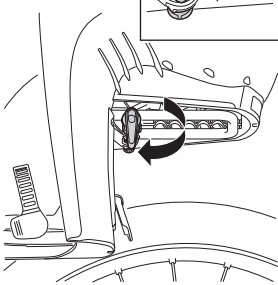
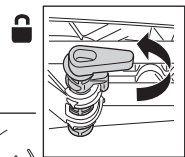
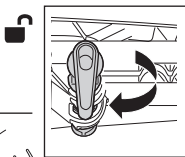



7

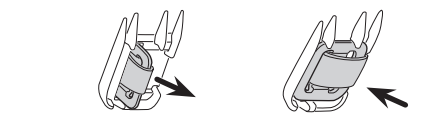
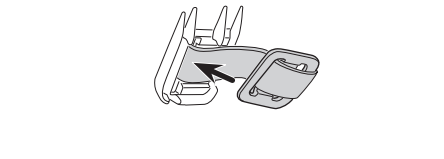
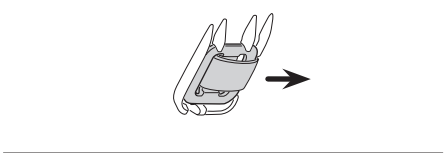
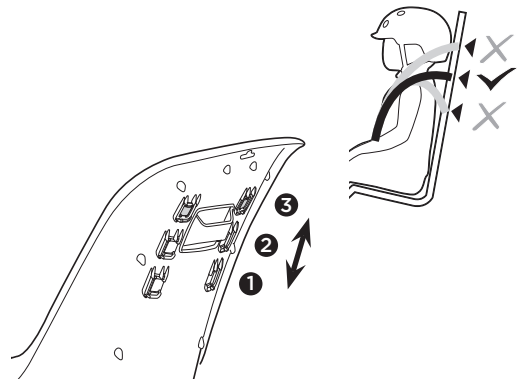
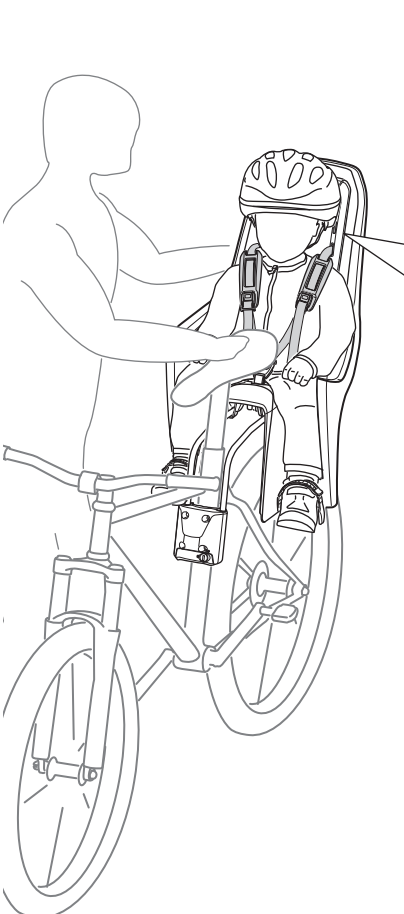
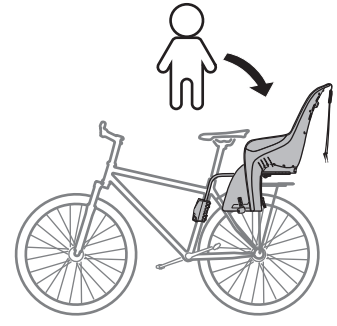
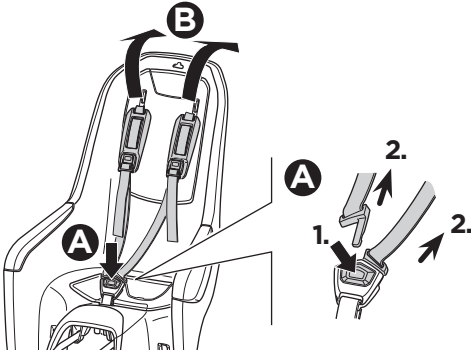

8

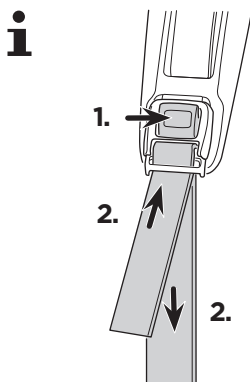
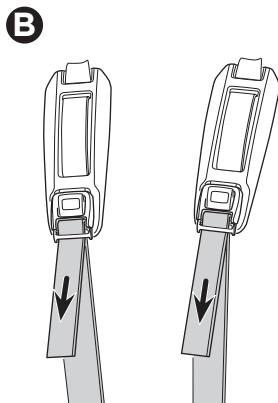
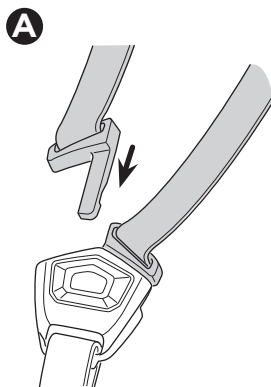
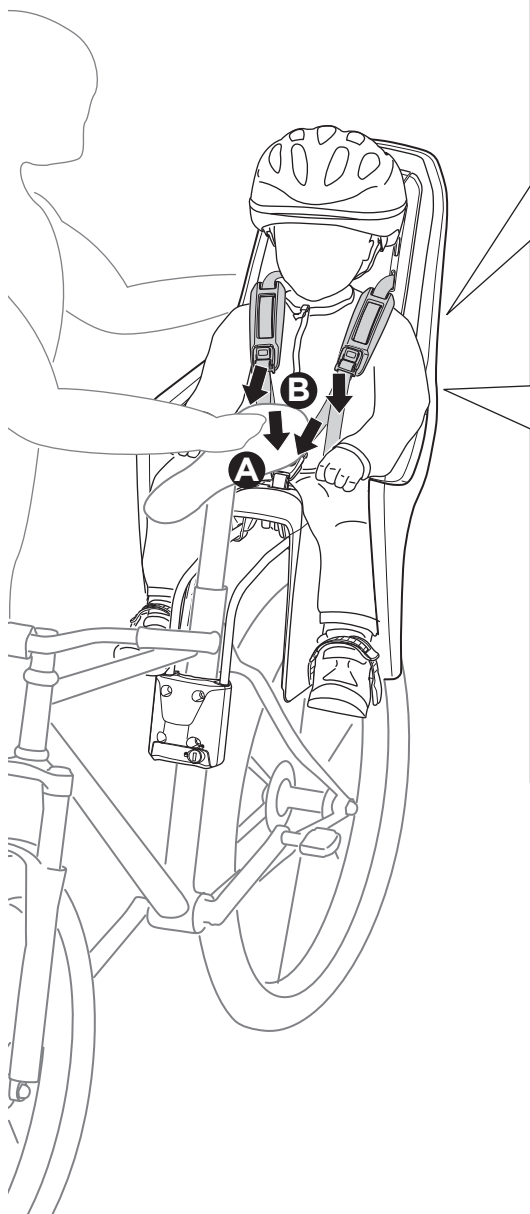

9

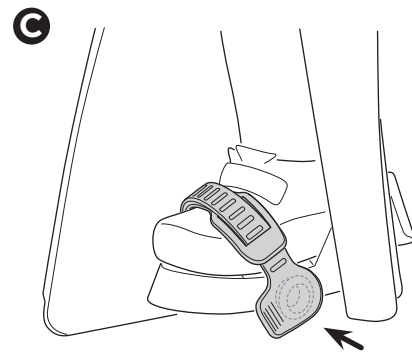
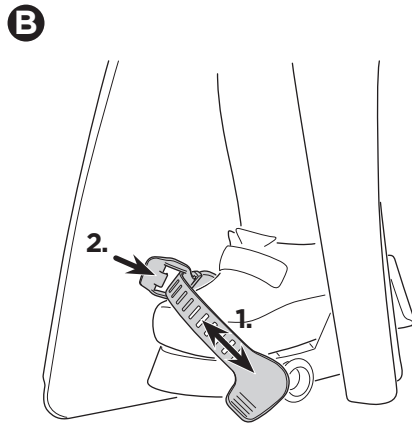
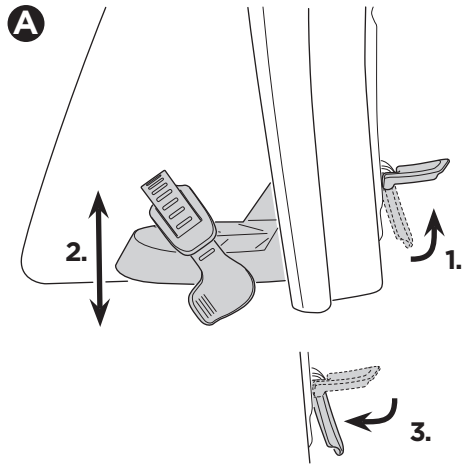
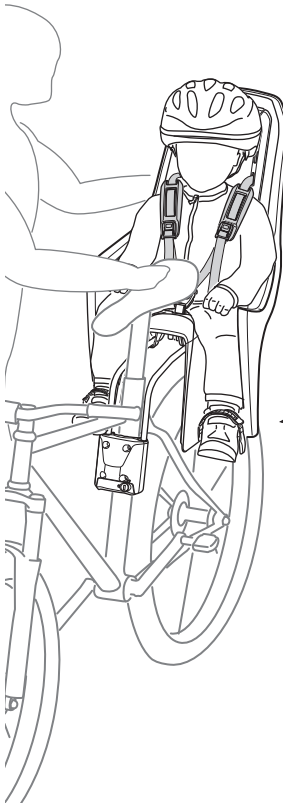

**i**

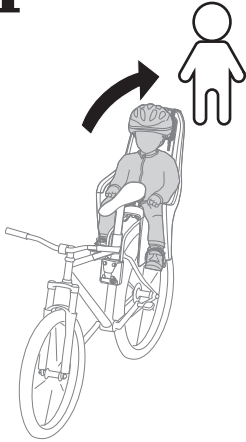

**A**



**B**

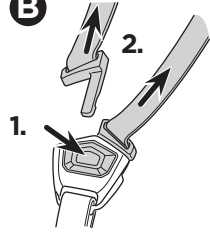

**C**



**D**

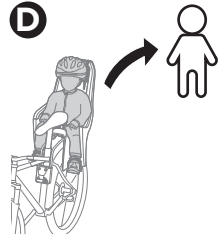

**A**

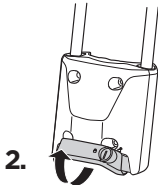
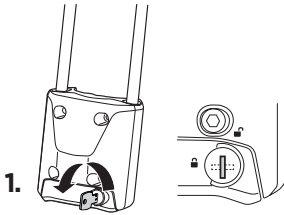

**B**

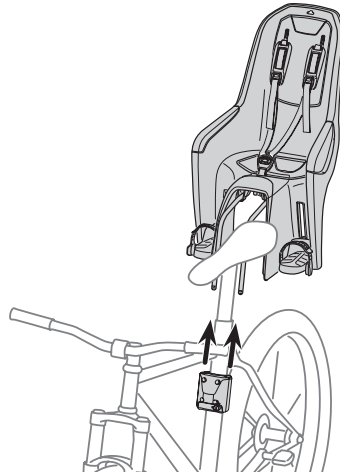

## Thule One-Key System

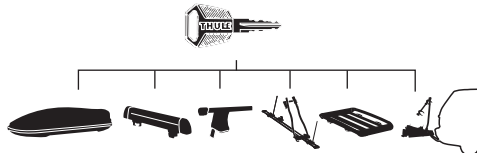

**450400** (x4)

**450600** (x6)

**450800** (x8)

**451200** (x12)